

ARBOGA



A 2508 U

		50Hz		60Hz	
	Ø 25 / 28 mm		105-210 350-700 445-890 1450-2900	130-260 420-840 535-1070 1740-3480	
	130 mm		0,65/0,90 kW	0,80/1,10 kW	
	M16 / M20		x = 415 mm y = 155 mm		
	MK 3		max ø 35 mm max ↓ 1 mm max < 80% >		
	584 x 242 mm		max ø 10 mm max ↓ 5 mm		



285

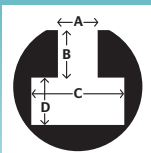

A 14 mm
B 10 mm
C 24 mm
D 10 mm

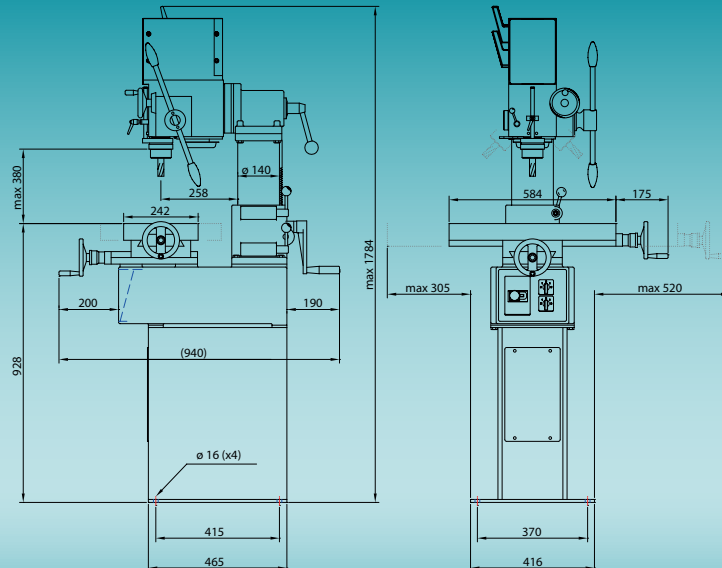

MSC
Machinery
Scandinavia

Tillbehör A 2508 U

Spare parts/Zubehör

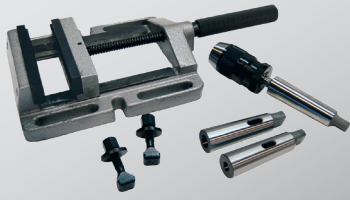

T25000



T25006

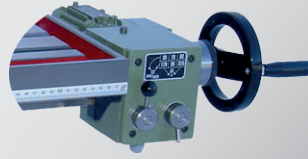

T25U20 - x = 400 mm



T25U03



T25U05

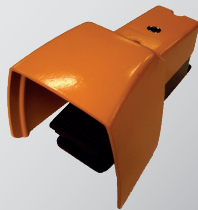

T25U09

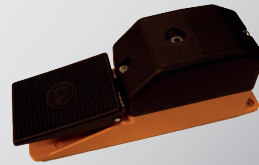

T25010

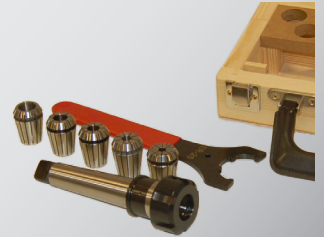

T25U42



T25U43



T30040 0-13 mm



T30041 3-16 mm



TFARGO

Std EU

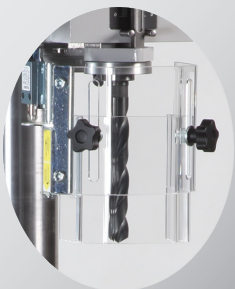

T25014 + T25052

MSC 
**Machinery
Scandinavia**

Machinery Scandinavia AB
570 83 Rosenfors, Sweden
Tel +46 495 49 700
Fax + 46 495 207 30
E-mail: sales@mscab.se
www.arbogamachinery.com